

0 601 641 703

Stand 02-04  
Issue 03-02-06

**Fig./Abb. 1**

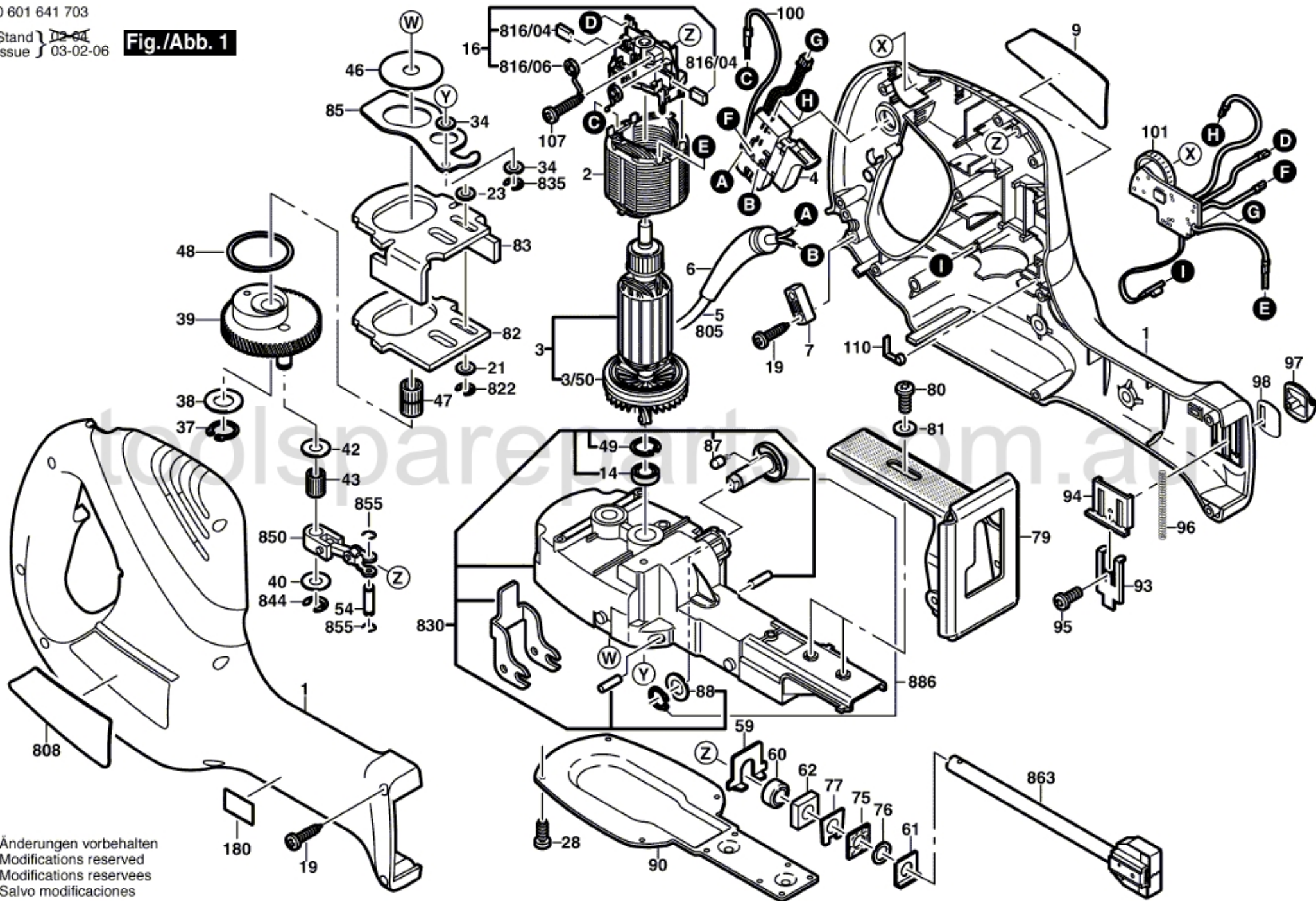

Änderungen vorbehalten  
Modifications reserved  
Modifications reserves  
Salvo modificaciones